

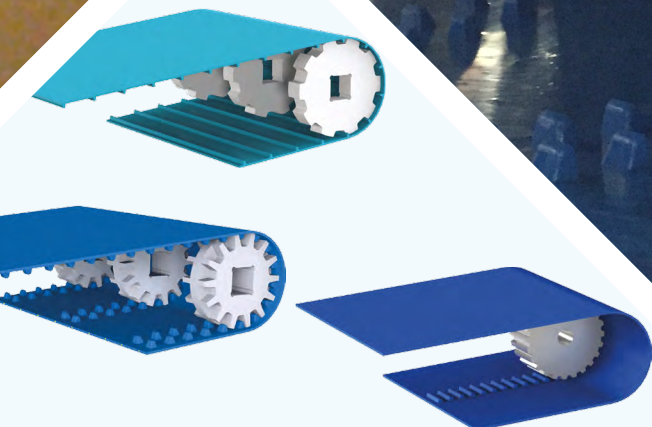

mafdel

**POSITIVELY DRIVEN
CONVEYOR BELTS**





mafdel



Mafdel	4
Applications	6
Advantages	8
Configuration	10
Characteristics	11
DEL/DRIVE®	12
POSITIVEBELT®	18
S/DRIVE®	26
DEL/SYNC®	28
Accessories	32
Tools	35
Mechanically fasten joins	37
Scrapers	38



THE EUROPEAN MANUFACTURER OF THERMOWELDABLE CONVEYOR BELTS

Mafdel is a family-owned company, which, since 1981, has been designing and manufacturing a wide range of thermoweldable conveyor belts, profiles and associated tools.

Mafdel's product range is manufactured in France at the group's 3 factories:



Saint-Georges d'Espéranche (38)



Heyrieux (38)



Vigneux de Bretagne (44)

Whether it's extruding, calendaring or fitting accessories, our production is managed by our experienced technicians, ensuring an optimised level of quality.

When you work with Mafdel, you can be assured that the solution will satisfy the most arduous challenges whether they be hygienic, mechanical or environmental.

AN EXTENSIVE RANGE



Thermoweldable profiles



Monolithic conveyor belts

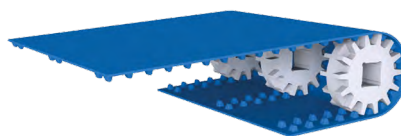

Positive drive belts



Welding and tooling

Accessories, such as guides, slides, scrapers and sprockets are all available.



A TEAM OF EXPERTS AT YOUR SERVICE

Our design and technical sales teams are at your service to help you to create belts to meet your product handling requirements.

Our large stocks and the flexibility of our production facilities ensures the shortest delivery times possible.



A WORLDWIDE PRESENCE

Mafdel products are available worldwide through a network of distributors and partners in over 60 countries.



Find your sales and technical contacts in France, abroad and at trade shows:



Mafdel is an active member of:



APPLICATIONS

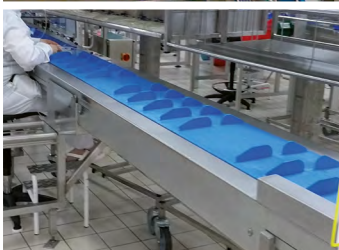
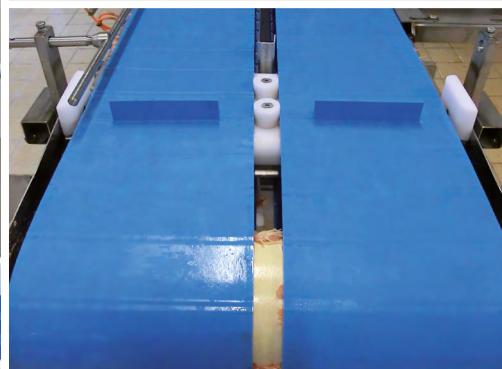
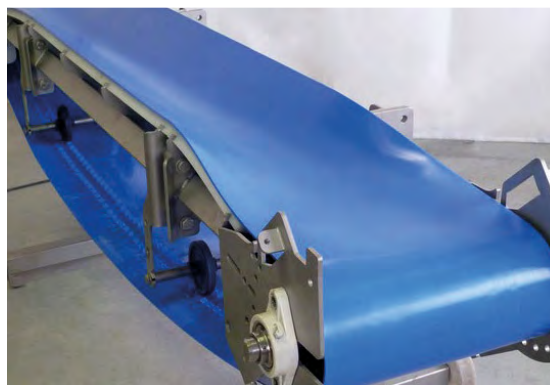
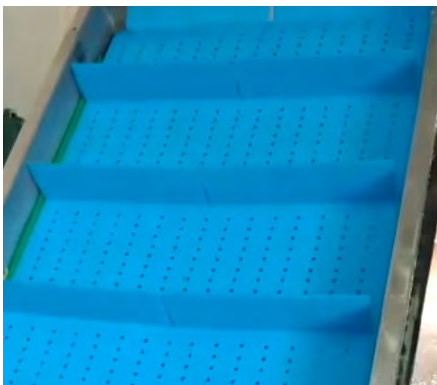
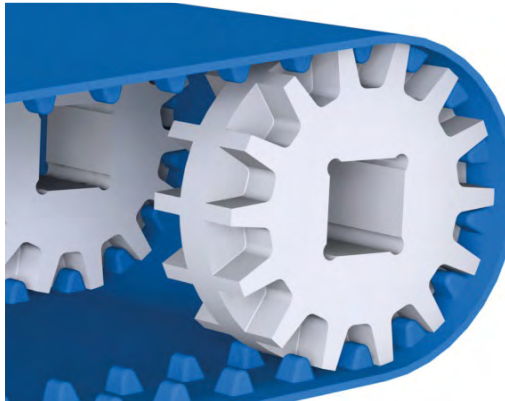
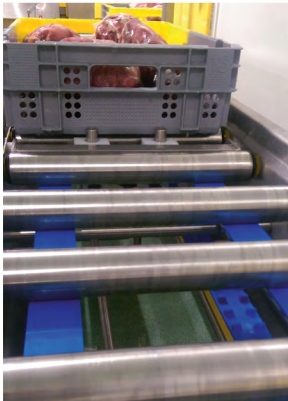

APPLICATIONS

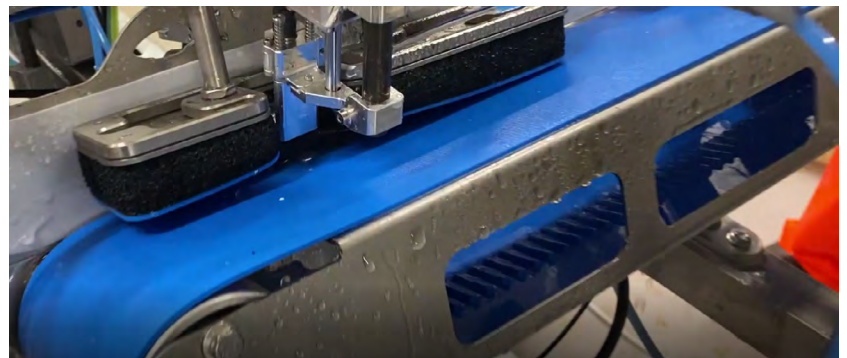
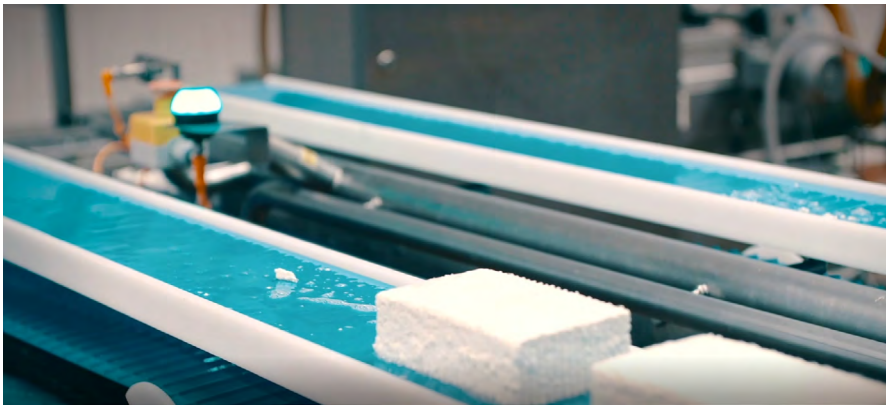
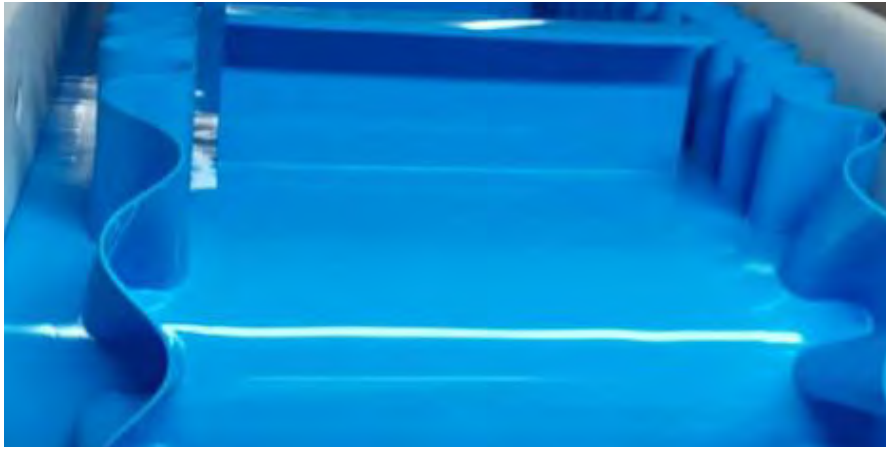

ADVANTAGES



Our positive drive homogeneous conveyor belts combine all the **advantages of modular belts and solid conveyor belts without the hygiene issues.**

Made of polyurethane or polyester elastomer, these belts are suitable **for most handling applications** in a variety of industries, particularly in the **food-processing industry.**



OPTIMIZED OPERATION

- No risk of slippage, even in greasy and humid environments
- Belts operate without tension, reducing the stress on the conveyor's mechanical components: shafts, anti-friction bearings, roller bearing, etc.
- No need for tensioners
- Lightweight
- Silent operation
- High abrasion and tear resistance
- For belts fitted in pairs, the positive drive ensures synchronized operation
- Fully moulded teeth



OPTIMAL HYGIENE LEVEL

- Fully EC-FDA compliant
- Solid impervious and rot-proof belt
- Labour and water saving
- Resistant to all common food industry chemicals including solvents, oils, greases...
- Suitable for scraper applications



ADVANTAGES



REDUCED PRODUCT CONTAMINATION

- Reduced risk of bacterial growth
- No fabric contamination removing the risk of fraying
- No detachable parts
- Reduced contamination risk



LOWER OPERATING COSTS

- Long service life
- Quick and easy to clean without dismantling
- Significant reduction in water and detergent consumption
- Low maintenance costs



	POSITIVELY DRIVEN CONVEYOR BELT	HOMOGENEOUS CONVEYOR BELT	MODULAR BELT
Hygiene and cleanability	+	+	-
Durability and impact resistance	+	+	-
Lower consumption of water and detergents	+	+	-
No slippage	+	-	+
Belt weight	+	+	-
No belt tensioning system	+	-	+
Reduced stress on conveyor components	+	-	+
Suitable for scrapers	+	+	-
Troughing applications	+	+	-

CONFIGURATION



HORIZONTAL CONVEYOR

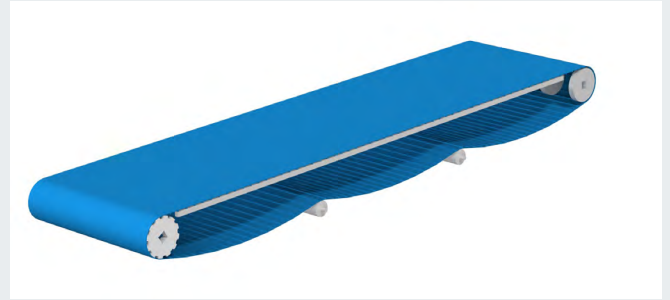

BIDIRECTIONAL CONVEYOR

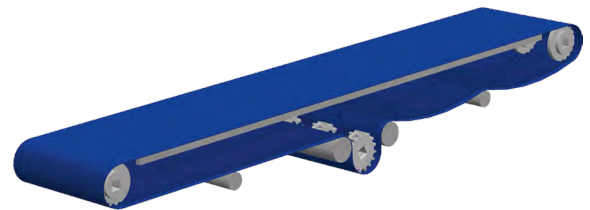

FLIGHTED AND SIDEWALL CONVEYOR



SWAN-NECK CONVEYOR



TROUGHED CONVEYOR

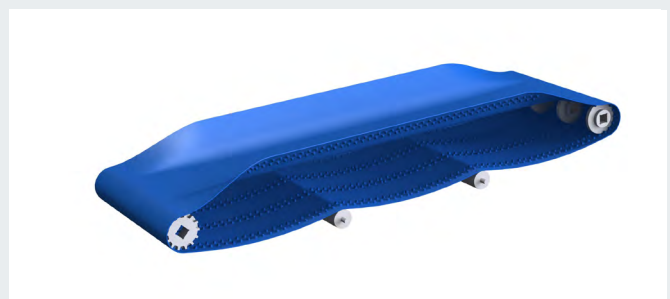



CHARACTERISTICS

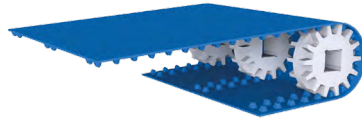
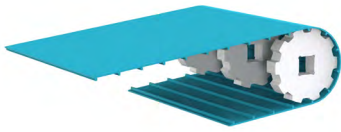

DEL/DRIVE®

Positive drive

Direct retrofit on modular applications

Teeth over the entire width

Operation without tension

POSITIVEBELT®

Self-tracking positive drive

Perfect tracking

Double rows of teeth

Operation without tension

S/DRIVE®

Positive drive

Perfect centring

One or two rows of teeth

Operation without tension

DEL/SYNC®

Fully synchronous drive

Accurate positioning

Centrally positioned teeth

Tensioned operation

Our positive drive belts comply with the most stringent international standards and help to provide an optimum level of hygiene to meet HACCP* requirements in the following areas:



Poultry



Meat



Fish



Cheese dairies



Fruit



Vegetables



Bakeries- Industrial pastry-making



Ready meals



Frozen foods

*HACCP : Hazard Analysis Critical Control Point

DEL/DRIVE® 50



“THE IDEAL ALTERNATIVE TO MODULAR BELTS”

	DEL/DRIVE® 50	DEL/DRIVE® 50	DEL/DRIVE® 50EM	DEL/DRIVE® 50EM	DEL/DRIVE® 50H
Reference	DDB50B3	DDB50B5	DDB50W3	DDB50B3EM	DDB50B3H
Material	Polyurethane	Polyurethane	Polyurethane	Polyurethane	Polyester elastomer
Colour	Blue	Blue	White	Blue	Blue
Food	CE / FDA	CE / FDA	CE / FDA	CE / FDA	CE / FDA
Top surface	Smooth	Smooth	Embossed	Embossed	Smooth
Hardness	95 ShA	95 ShA	95 ShA	95 ShA	55 ShD
Pitch +/- 0.3 (mm)	50	50	50	50	49.5
Thickness (mm)	3	5	3	3	3
Overall thickness (mm)	8.6	10.6	8.6	8.6	8.3
Maximum width (mm)	1 800	1 800	1 800	1 800	1 800*
Weights	4.8 kg/m ²	7.3 kg/m ²	4.8 kg/m ²	4.8 kg/m ²	4.4 kg/m ²
Min. pulley diameter (mm)	95	95	95	95	128
Min. pulley diameter - back flex (mm)	100	100	100	100	150
Temperature range	-20°C to +60°C	-20°C to +60°C	-20°C to +60°C	-20°C to +60°C	-20°C to +80°C
Traction force at 2,5% elongation for 100 mm width	65 daN	65 daN	65 daN	65 daN	160 daN
Friction coefficient					
On HDPE bed	0.2	0.2	0.2	0.2	0.15
On stainless steel bed	0.52	0.52	0.52	0.52	0.45

* For any width > 1200mm, please contact us

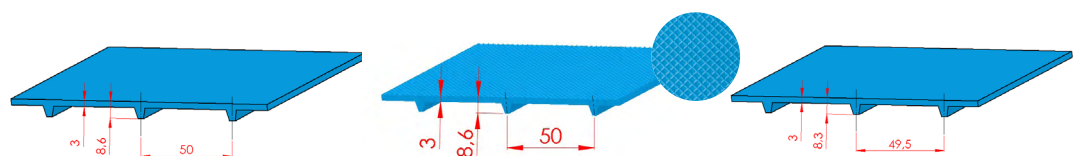

DEL/DRIVE® 50

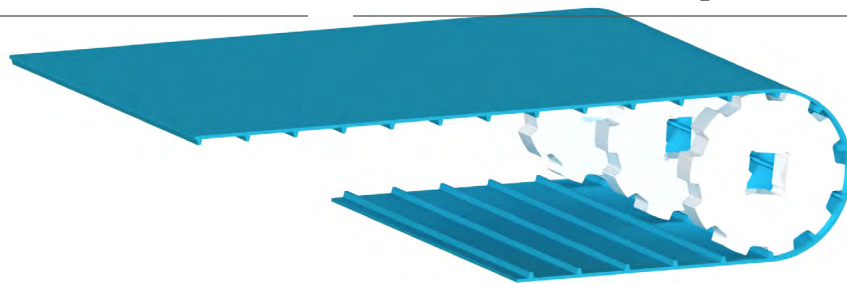

DEL/DRIVE® 50EMLT	DEL/DRIVE® 50AM	DEL/DRIVE® 50AMEM	DEL/DRIVE® 50MD	DEL/DRIVE® 50-25
DDB50B3EMLT	DDB50B3AM	DDB50B3AMEM	DDB50B3MD	DDB50-25B12
Polyurethane	Polyurethane	Polyurethane	Polyurethane Metal Detectable	Polyurethane
Blue	Dark blue	Dark blue	Dark blue	Blue
CE / FDA	CE / FDA	CE / FDA	CE	CE / FDA
Embossed	Smooth	Embossed	Smooth	With teeth
92 ShA	95 ShA	95 ShA	95 ShA	95 ShA
50	50	50	50	50
3	3	3	3	3
8.6	8.6	8.6	8,6	12
1800	1 800	1 800	1800	1 800
4.8 kg/m ²	4.8 kg/m ²	4.8 kg/m ²	4,8 kg/m ²	4.8 kg/m ²
95	95	95	95	95
80	100	100	100	100
-30°C to +50°C	-20°C to +60°C	-20°C to +60°C	-20°C to +60°C	-20°C to +60°C
35 daN	65 daN	65 daN	65 daN	65 daN
0.25	0.2	0.2	0,2	0.2
0.6	0.52	0.52	0,52	0.52

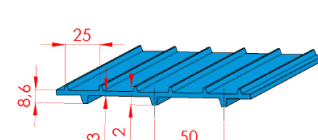
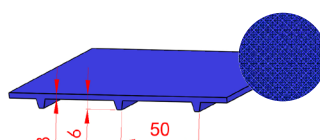
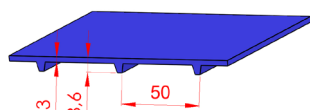
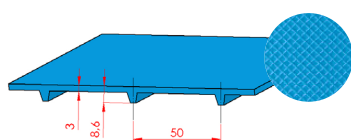

DEL/DRIVE® 50



The DEL/DRIVE® positive drive belt meets the **most stringent standards of hygiene** and is **the ideal alternative to conventional modular belts**. It replaces a modular belt without any modifications. It is either driven on a sprocket or a motorized drum.

The DEL/DRIVE® belt is installed **without tension**, thereby reducing stress on the conveyor's mechanical components: shafts, anti-friction bearings, roller bearing, etc.

DEL/DRIVE® can be configured with flights, sidewalls or other profiles.

The DEL/DRIVE® comes in several versions to meet all needs:

The DEL/DRIVE® 50 belt in polyurethane is both flexible and has high tensile strength. It is the ideal solution for the conveyance of light to medium-weight loads. The DEL/DRIVE® 50 is available in blue or white.

The DEL/DRIVE® 50EM belt is a variant of the DEL/DRIVE® 50 belt with a structured top side for improved transport of frozen products.

The DEL/DRIVE® 50H belt in polyester elastomer is recommended for medium to heavy loads and can be used with long centre-to-centre distances. In certain cases, its high tensile strength and low friction coefficient permits accumulation of transported products. It can withstand higher peak temperatures, depending on the load.

The DEL/DRIVE® 50EMLT belt is specially designed to operate in very low ambient temperatures. Its embossed top surface facilitates the conveyance of frozen products.

The DEL/DRIVE® 50AM belt has the same characteristics as the DEL/DRIVE® 50 belt plus an infused antimicrobial treatment. DEL/DRIVE® 50AM improves food safety by inhibiting the proliferation of bacteria.

This prevents the contamination of transported products.
A further benefit is the reduction of odours and cleaning cycles.

The DEL/DRIVE® 50AMEM belt has an infused antimicrobial treatment and an embossed top surface that reduces adherence of the products on the belt.

The DEL/DRIVE® 50-25 belt has 50mm drive teeth on one face, and 25mm drive teeth on the other allowing one side to drive and the other to act as low flights for increased grip.

DEL/DRIVE® 50



SPROCKETS AND IDLER WHEELS



REFERENCE	PRODUCT	MATERIAL	COLOUR	OUTER DIAMETER (mm)	NUMBER OF TEETH	SQUARE BORE (mm)	WIDTH (mm)
P50BUN06	Sprocket	HDPE	Blue	95	6	40	32
R50BUN06	Wheel	HDPE	Blue	83	-	40	32
P50BUN08	Sprocket	HDPE	Blue	128	8	40	32
R50BUN08	Wheel	HDPE	Blue	116	-	40	32
P50BUN10	Sprocket	HDPE	Blue	161	10	40	32
R50BUN10	Wheel	HDPE	Blue	149	-	40	32
P50BUN12	Sprocket	HDPE	Blue	193	12	40	32
R50BUN12	Wheel	HDPE	Blue	181	-	40	32

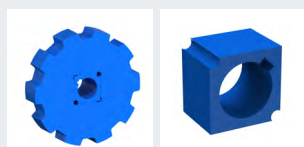

The standard sprockets we offer have a square bore for a 40x40 mm drive shaft.

They can be mounted on other shafts with special adapters.
Please enquire for any other dimensions of round or square shaft.

SPROCKETS FOR DRIVING DRUM

HDPE sprockets on stainless steel ring, locked with set screw.

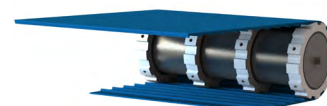

REFERENCE	MATERIAL	COLOUR	OUTER DIAMETER (mm)	NUMBER OF TEETH	DRUM MOTOR		WIDTH (mm)
P50BUN09R122	HDPE	Blue	144	9	113i	DM0113	34
P50BUN12R147	HDPE	Blue	193	12	138i	DM0138	34
P50BUN14R174	HDPE	Blue	225	14	165i	DM0165	34

DRIVING DRUM WITH PROFILED POLYURETHANE LINING

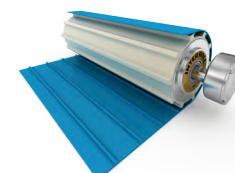

DRIVING DRUM	80i	113i	138i	165i
NUMBER OF TEETH	-	9	10	12
OUTSIDE DIAMETER PACKING (MM) (+0,5 ; -1)	-	142,5	158	190,2

DEL/DRIVE® 25



«**POSITIVE DRIVE ON SMALL PULLEY DIAMETERS**»

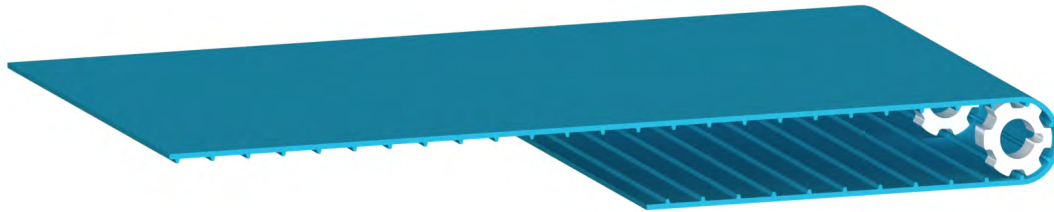

DEL/DRIVE® 25

	DDB25B2	DDB25B2.8	DDB25B2.8EM
Reference	DDB25B2	DDB25B2.8	DDB25B2.8EM
Material	Polyurethane	Polyurethane	Polyurethane
Colour	Blue	Blue	Blue
Food	CE / FDA	CE / FDA	CE / FDA
Top surface	Smooth	Smooth	Embossed
Hardness	93 ShA	93 ShA	93 ShA
Pitch (mm)	25.3	25.3	25.3
Thickness (mm)	2	2,8	2,8
Overall thickness (mm)	6	7	7
Max. width (mm)	1 800	1 800	1 800
Weights	3 kg/m ²	4 kg/m ²	4 kg/m ²
Min. pulley diameter (mm)	48	56,7	56,7
Min. pulley diameter - back flex (mm)	50	60	60
Temperature range	-20°C / +60°C		
Traction force at 2% elongation	25 daN for a width of 100 mm	30 daN for a width of 100 mm	30 daN for a width of 100 mm
Friction coefficient			
On HDPE bed	0,22		
On stainless steel bed	0,55		

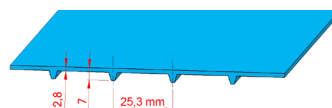
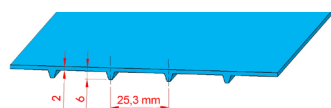



DEL/DRIVE® 25

The DEL/DRIVE® 25 belt is flexible, light with a small pitch and thickness for smaller diameter sprockets. It thus reduces the space requirements of conveyors and facilitates the transfer of transported products.



DRIVE SPROCKETS



REFERENCE	MATERIAL	COLOUR	OUTER DIAMETER (mm)	NUMBER OF TEETH	BORE (mm)		WIDTH (mm)
					square	∅ round	
P25BUN06R25	HDPE	Blue	48	6	-	25	25
P25BUN07R25	HDPE	Blue	56,7	7	-	25	25
P25BUN08R25	HDPE	Blue	65	8	-	25	25
P25BUN10C40	HDPE	Blue	81	10	40	-	25
P25BUN12C40	HDPE	Blue	97,5	12	40	-	25

DRIVING DRUM WITH PROFILED

DRIVING DRUM	DM0080 80i	DM0113 113i	DM0138 138i
NUMBER OF TEETH	13	18	20
OUTSIDE DIAMETER PACKING (MM) (+0,5 ; -1)	104,2	144,3	161,5

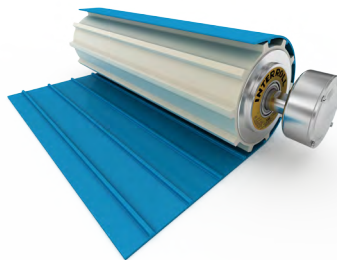

For the return of the DEL/DRIVE® 25 belt, we recommend a running roller with a larger diameter rather than the recommended minimum diameter.

POSITIVEBELT®



«SELF-TRACKING POSITIVE DRIVE BELT»

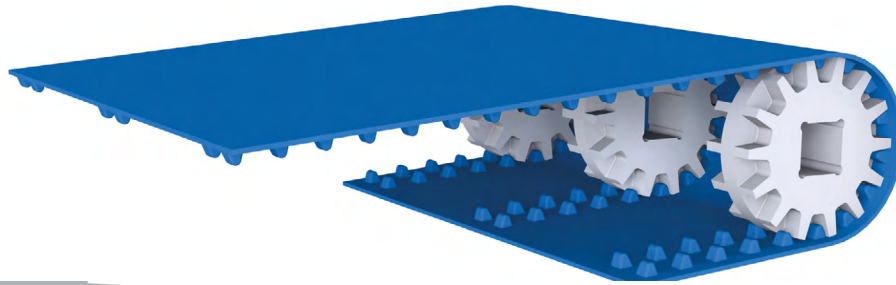

POSITIVEBELT® P02

Reference	PO331LB2	PO331LW2	PO331RLB2	PO331LB2AM	PO331LB2H
Material	Polyurethane	Polyurethane	Polyurethane reinforced aramid ropes	Antimicrobial polyurethane	Polyester elastomer
Colour	Blue	White	Blue	Dark blue	Blue
Food	CE / FDA	CE / FDA	CE / FDA	CE	CE / FDA
Top surface	Smooth	Smooth	Smooth	Smooth	Smooth
Hardness	95 ShA	95 ShA	95 ShA	95 ShA	55 ShD
Aramid cable reinforcement	no	no	yes	no	no
Pitch +/- 0.3 (mm)	31.5	31.5	31,5	31.5	30.8
Thickness (mm)	3.2	3.2	3,2	3.2	3.2
Distance between rows of teeth (mm)	200	200	200	200	196
Max. width (mm)	1 000	1 000	1 000	1 000	1 000
Weights	4.8 kg/m ²	4.8 kg/m ²	5 kg/m ²	4.8 kg/m ²	4.4 kg/m ²
Min. pulley diameter (mm)	100	100	100	100	120
Min. pulley diameter - back flex (mm)	100	100	100	100	120
Temperature range	-20°C / +75°C	-20°C / +75°C	-20°C / +75°C	-20°C / +75°C	-20°C / +80°C
Traction force for a width of 100 mm	70 daN at 3% elongation	70 daN at 3% elongation	120daN at 2.5% elongation	70 daN at 3% elongation	165 daN at 2.5% elongation
Friction coefficient					
On HDPE bed	0.35	0.35	0,35	0.35	0.15
On stainless steel bed	0.6	0.6	0,6	0.6	0.45

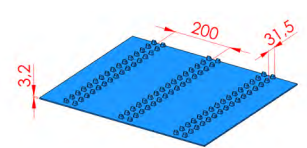
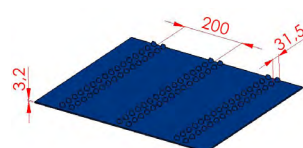
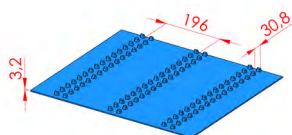



POSITIVEBELT®

The positive drive thermo-weldable POSITIVEBELT® P02 offers **exceptional guidance thanks to the dual row of teeth**.

The **perfectly smooth top side** makes it easy to clean and maintains an **optimal level of hygiene**.

The belt is guided within the gaps of the conveyor support rails. The belt tolerates side loads without the risk of tracking off.



The belt is driven by sprockets mounted on a square shaft or a drum motor.

The POSITIVEBELT® P02 belt is mounted **without tension**, thus reducing the stress on the mechanical parts of the conveyor: shafts, bearings, etc.

An open, cantilevered conveyor design is possible due to the absence of belt tension, making it easier to remove and re-fit the belt when it is regularly used.

The belt can be equipped with **cleats** or **sidewalls**.

The POSITIVEBELT® P02 belt can be trough-shaped.

POSITIVEBELT® P0331LB2AM is available with an **antimicrobial treatment** in the mass. This treatment inhibits the growth of bacteria and prevents contamination of the products being transported. It also improves food safety, reduces the development of odours and facilitates the cleaning of conveyor belts.

POSITIVEBELT® P0331LB2 is an aramid cord reinforced version which limits the elongation.

The POSITIVEBELT® P0331LB2H polyester elastomer belt is recommended for medium to heavy duty conveying and can be used on large centre distances. Its high tensile strength and low coefficient of friction allow, in certain cases, the use with accumulation of the transported products. It can accept higher peak temperatures, depending on the loads carried.

POSITIVEBELT Polyurethane
POSITIVEBELT Polyester elastomer

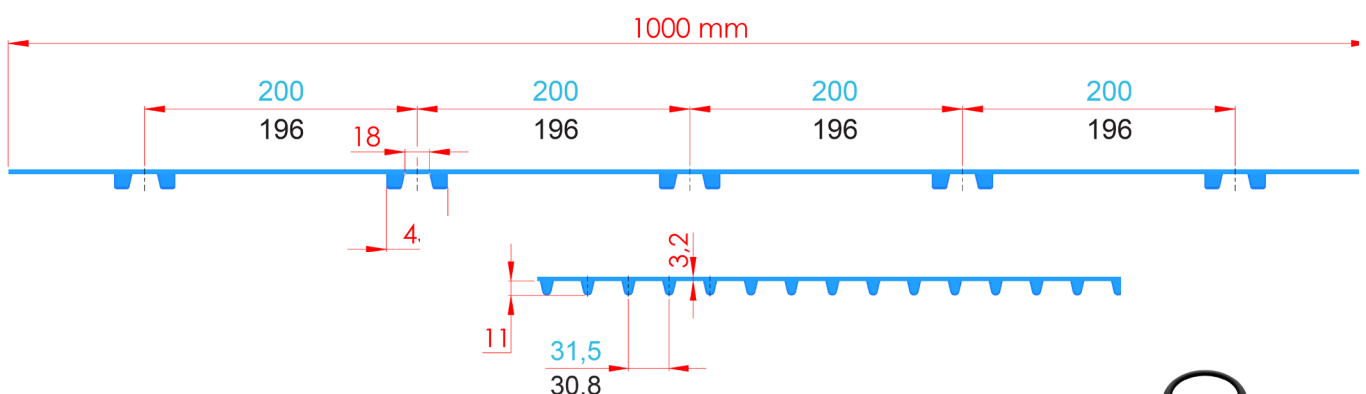



SPROCKETS, WHEELS AND DISKS FOR BELTS P0331LB2 AND P0331LB2AM



REFERENCE	PRODUCT	MATERIAL	COLOUR	OUTER DIAMETER (mm)	NUMBER OF TEETH	SQUARE BORE (mm)	WIDTH (mm)
P31BUN10C40	Sprocket	HDPE	Blue	100	10	40	50
R31BUN10C40	Wheel				-		
D31BUN10C40	Disk				-		
P31BUN12C40	Sprocket	HDPE	Blue	120	12	40	50
R31BUN12C40	Wheel				-		
D31BUN12C40	Disk				-		
P31BUN14C40	Sprocket	HDPE	Blue	142	14	40	50
R31BUN14C40	Wheel				-		
D31BUN14C40	Disk				-		
P31BUN16C40	Sprocket	HDPE	Blue	162	16	40	50
R31BUN16C40	Wheel				-		
D31BUN16C40	Disk				-		
P31BUN20C40	Sprocket	HDPE	Blue	202	20	40	50
R31BUN20C40	Wheel				-		
D31BUN20C40	Disk				-		

Sprockets, wheels and disks with 1.5" square bore on request

The standard sprockets we offer have a square bore for a 40x40 mm drive shaft.

They can be mounted on other shafts with special adapters.
Please enquire for any other dimensions of round or square shaft.

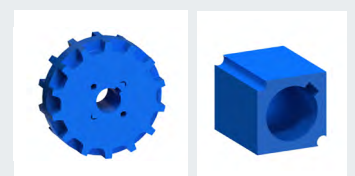

SPROCKETS FOR DRIVING DRUM

HDPE sprockets on stainless steel ring, locked with set screw.

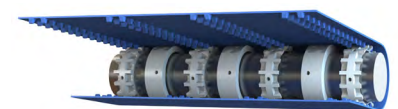

REFERENCE	PRODUCT	MATERIAL	COLOUR	OUTER DIAMETER (mm)	NUMBER OF TEETH	DRIVING DRUM		WIDTH (mm)
P31BUN15R122	Sprocket	HDPE	Blue	152	15	113i	DM0113	50
R31BUN15R122	Wheel	HDPE	Blue	152	-	113i	DM0113	50
P31BUN18R147	Sprocket	HDPE	Blue	182	18	138i	DM0138	50
R31BUN18R147	Wheel	HDPE	Blue	182	-	138i	DM0138	50
P31BUN20R174	Sprocket	HDPE	Blue	202	20	165i	DM0165	50
R31BUN20R174	Wheel	HDPE	Blue	202	-	165i	DM0165	50



SPROCKETS, WHEELS AND DISKS FOR BELTS P0331LB2H



REFERENCE	PRODUCT	MATERIAL	COLOUR	OUTER DIAMETER (mm)	NUMBER OF TEETH	SQUARE BORE (mm)	WIDTH (mm)
P30BUN14C40	Sprocket	HDPE	Blue	137	14	40	50
R30BUN14C40	Wheel				-		
D30BUN14C40	Disk				-		
P30BUN16C40	Sprocket	HDPE	Blue	157	16	40	50
R30BUN16C40	Wheel				-		
D30BUN16C40	Disk				-		
P30BUN20C40	Sprocket	HDPE	Blue	197	20	40	50
R30BUN20C40	Wheel				-		
D30BUN20C40	Disk				-		

Sprockets, wheels and disks with 1.5" square bore on request

The standard sprockets we offer have a square bore for a 40x40 mm drive shaft.

They can be mounted on other shafts with special adapters.
Please enquire for any other dimensions of round or square shaft.

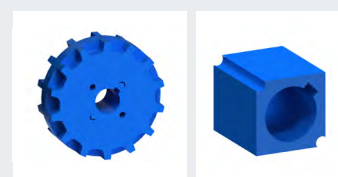

SPROCKETS FOR DRIVING DRUM

HDPE sprockets on stainless steel ring, locked with set screw.

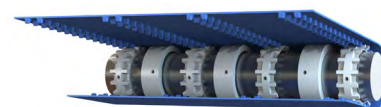

REFERENCE	PRODUCT	MATERIAL	COLOUR	OUTER DIAMETER (mm)	NUMBER OF TEETH	DRIVING DRUM		WIDTH (mm)
P30BUN15R122	Sprocket	HDPE	Blue	147	15	113i	DM0113	50
R30BUN15R122	Wheel	HDPE	Blue		-	113i	DM0113	50
P30BUN18R147	Sprocket	HDPE	Blue	177	18	138i	DM0138	50
R30BUN18R147	Wheel	HDPE	Blue		-	138i	DM0138	50
P30BUN20R174	Sprocket	HDPE	Blue	197	20	165i	DM0165	50
R30BUN20R174	Wheel	HDPE	Blue		-	165i	DM0165	50

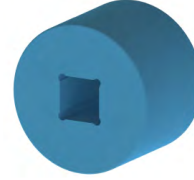

WIDE SPROCKETS AND WHEELS FOR BELTS P0331LB2 AND P0331LB2AM

REFERENCE	PRODUCT	MATERIAL	COLOUR	OUTER DIAMETER (mm)	NUMBER OF TEETH	SQUARE BORE (mm)	WIDTH (mm)
P31LBUN10C40	Sprocket	HDPE	Blue	100	10	40	100
R31LBUN10C40	Wheel				-		
P31LBUN12C40	Sprocket	HDPE	Blue	120	12	40	100
R31LBUN12C40	Wheel				-		
P31LBUN14C40	Sprocket	HDPE	Blue	142	14	40	100
R31LBUN14C40	Wheel				-		
P31LBUN16C40	Sprocket	HDPE	Blue	162	16	40	100
R31LBUN16C40	Wheel				-		
P31LBUN20C40	Sprocket	HDPE	Blue	202	20	40	100
R31LBUN20C40	Wheel				-		

WIDE SPROCKETS AND WHEELS FOR BELTS P0331LB2H

REFERENCE	PRODUCT	MATERIAL	COLOUR	OUTER DIAMETER (mm)	NUMBER OF TEETH	SQUARE BORE (mm)	WIDTH (mm)
P30LBUN14C40	Sprocket	HDPE	Blue	137	14	40	100
R30LBUN14C40	Wheel				-		
P30LBUN16C40	Sprocket	HDPE	Blue	157	16	40	100
R30LBUN16C40	Wheel				-		
P30LBUN20C40	Sprocket	HDPE	Blue	197	20	40	100
R30LBUN20C40	Wheel				-		

Sprockets, wheels and disks with 1.5" square bore on request



POSITIVEBELT® P01 Reinforced

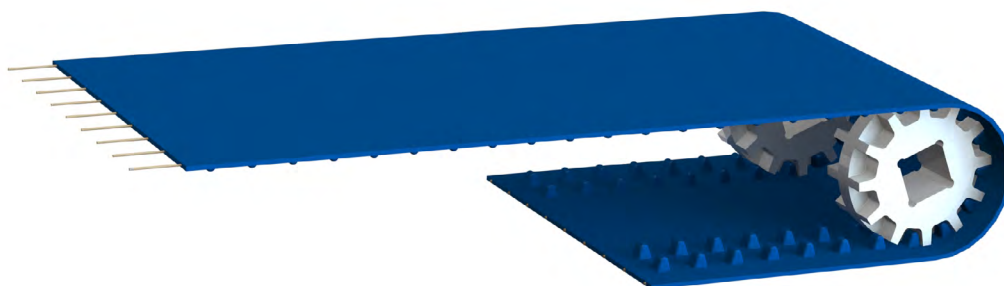

POSITIVEBELT® P01

Reference	PO131LB	PO231RLB	PO231RLBPI	PO331RLB	PO331RLBPI
Material	Polyurethane	Polyurethane		Polyurethane	
Colour	Blue	Blue		Blue	
Food	CE / FDA	CE / FDA		CE / FDA	
Top surface	Smooth	Smooth	Spikes	Smooth	Spikes
Hardness	90 ShA	92 ShA		95 ShA	
Aramid cable reinforcement	no	yes		yes	
Pitch (mm)	30,8	30,8		30,8	
Thickness (mm)	2	3	4	3,5	4
Distance between rows of teeth (mm)	174	174		174	
Max width(mm)	400	400		400	
Weights (kg/m ²)	3,2	4,7		5,5	
Min. pulley diameter (mm)	50	75		105	
Min. pulley diameter - back flex (mm)	50	75		105	
Temperature range	-25°C / +60°C	-25°C / +70°C		-20°C / +80°C	
Traction force at 2% elongation	15 daN	120 daN		200 daN	
Friction coefficient					
On HDPE bed	0,4	0,35		0,3	
On stainless steel bed	0,7	0,6		0,5	

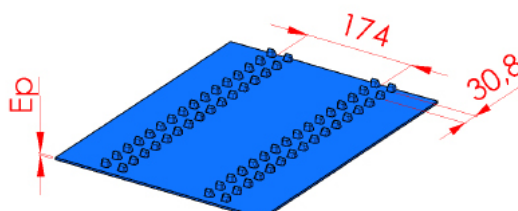

POSITIVEBELT® P01 Reinforced



POSITIVEBELT® P01 is a reinforced version with aramid cords (except P0131LB). It is particularly suitable for applications requiring **good adhesion** or **small pulley diameters**. The distributed reinforcement allows **a high load capacity**, even on small widths. It is possible to add cleats or sidewalls. Top side with spikes on request.

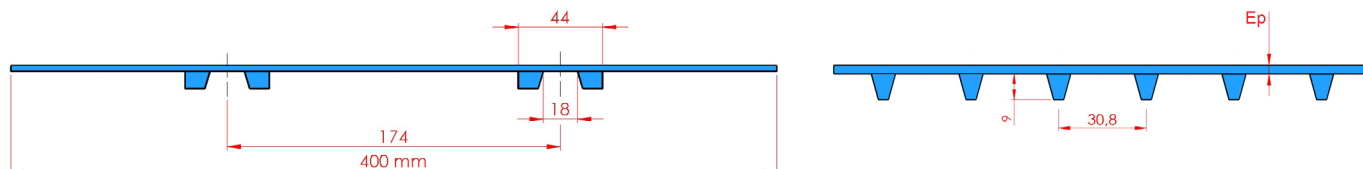

SPROCKETS, WHEELS ET DISKS FOR BELTS P01



REFERENCE	PRODUCT	MATERIAL	COLOUR	OUTER DIAMETER (mm)	NUMBER OF TEETH	SQUARE BORE (mm)	WIDTH (mm)
P30BUN10C40	Sprocket	HDPE	Blue	97	10	40	50
R30BUN10C40	Wheel				-		
D30BUN10C40	Disk				-		
P30BUN12C40	Sprocket	HDPE	Blue	117	12	40	50
R30BUN12C40	Wheel				-		
D30BUN12C40	Disk				-		
P30BUN14C40	Sprocket	HDPE	Blue	137	14	40	50
R30BUN14C40	Wheel				-		
D30BUN14C40	Disk				-		
P30BUN16C40	Sprocket	HDPE	Blue	157	16	40	50
R30BUN16C40	Wheel				-		
D30BUN16C40	Disk				-		
P30BUN20C40	Sprocket	HDPE	Blue	197	20	40	50
R30BUN20C40	Wheel				-		
D30BUN20C40	Disk				-		

Sprockets, wheels and disks with 1.5" square bore on request

The standard sprockets we offer have a square bore for a 40x40 mm drive shaft.

They can be mounted on other shafts with special adapters.
Please enquire for any other dimensions of round or square shaft.

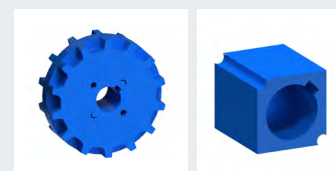



POSITIVEBELT® P01 Reinforced

SPROCKETS AND WHEELS ON DRIVING DRUM FOR BELTS P01

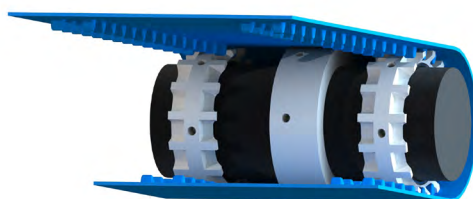

HDPE sprockets to be mounted on stainless steel ring, locked with pressure screw.

REFERENCE	PRODUCT	MATERIAL	COLOUR	OUTER DIAMETER (mm)	NUMBER OF TEETH	DRIVING DRUM		WIDTH (mm)
P30BUN15R122	Sprocket	HDPE	Blue	147	15	113i	DM0113	50
R30BUN15R122	Wheel	HDPE	Blue		-	113i	DM0113	50
P30BUN18R147	Sprocket	HDPE	Blue	177	18	138i	DM0138	50
R30BUN18R147	Wheel	HDPE	Blue		-	138i	DM0138	50
P30BUN20R174	Sprocket	HDPE	Blue	197	20	165i	DM0165	50
R30BUN20R174	Wheel	HDPE	Blue		-	165i	DM0165	50

WIDE SPROCKETS AND WHEELS FOR BELTS P01

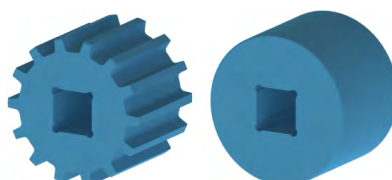

REFERENCE	PRODUCT	MATERIAL	COLOUR	OUTER DIAMETER (mm)	NUMBER OF TEETH	SQUARE BORE (mm)	WIDTH (mm)
P30LBUN10C40	Sprocket	HDPE	Blue	97	10	40	100
R30LBUN10C40	Wheel				-		
P30LBUN12C40	Sprocket	HDPE	Blue	117	12	40	100
R30LBUN12C40	Wheel				-		
P30LBUN14C40	Sprocket	HDPE	Blue	137	14	40	100
R30LBUN14C40	Wheel				-		
P30LBUN16C40	Sprocket	HDPE	Blue	157	16	40	100
R30LBUN16C40	Wheel				-		
P30LBUN20C40	Sprocket	HDPE	Blue	197	20	40	100
R30LBUN20C40	Wheel				-		

Sprockets and wheels with 1.5" square bore on request



«THE STANDARD OF POSITIVE BELT»

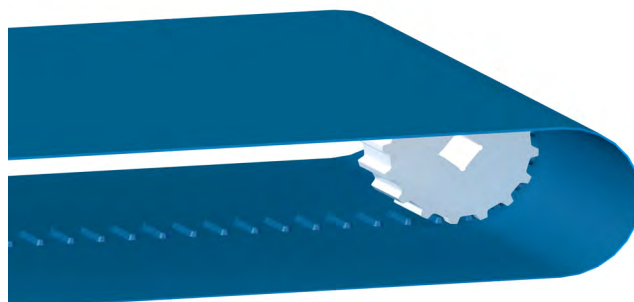

	S/DRIVE	S/DRIVE EMBOSSED	S/DRIVE ANTIMICROBIAL	S/DRIVE THICKNESS 5
Reference	SDB40B3	SDB40B3EM	SDB40B3AM	SDB40B5
Material	Polyurethane	Polyurethane	Polyurethane	Polyurethane
Colour	Blue	Blue	Blue AM	Blue
Food approval	CE / FDA	CE / FDA	CE	CE / FDA
Top surface texture	Smooth	Embossed	Smooth	Smooth
Hardness	95 ShA	95 ShA	95 ShA	95 ShA
Pitch (mm) ± 0,3 (mm)	39,7	39,7	39,7	39,7
Thickness (mm)	3	3	3	5
Total thickness (mm)	10,6	10,6	10,6	12,6
Tooth row distance (mm)	602	602	602	602
Max width (mm)	1 650	1 650	1 650	1 650
Weight	3,6 kg/m ²	3,6 kg/m ²	3,6 kg/m ²	6,7 kg/m ²
Minimum pulley diameter (mm)	100	100	100	230
Minimum back flex diameter (mm)	100	100	100	230
Operating temperatures	-20°C to +60°C	-20°C to +60°C	-20°C to +60°C	-20°C to +60°C
Traction force 2.5% lengthening per 100 mm width	65 daN	65 daN	65 daN	110 daN
Friction coefficient				
On HDPE bed	0,2	0,2	0,2	0,2
On stainless steel bed	0,52	0,52	0,52	0,52

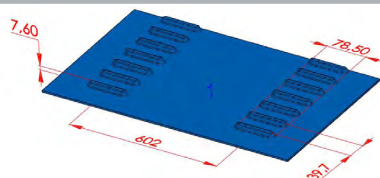

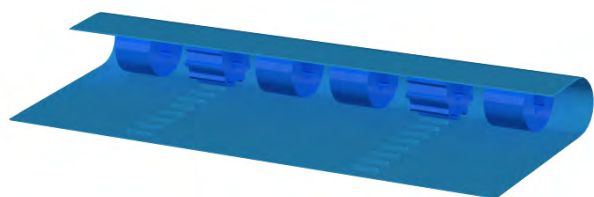

Motorisation

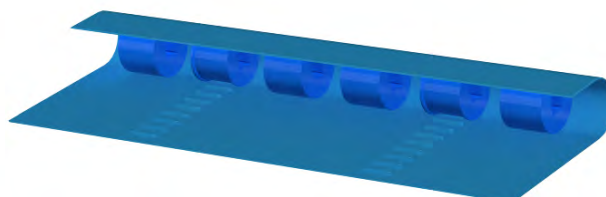

Reverse

SPROCKETS, WHEELS AND PULLEYS FOR BELTS SDB40B3

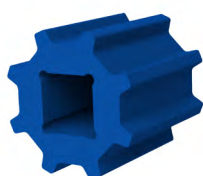

REFERENCE	PRODUCT	MATERIAL	COLOUR	OUTER DIAMETER (mm)	INSIDE DIAMETER (mm)	NUMBER OF TEETH	SQUARE BORE (mm)	WIDTH (mm)
P40BUN08C40	Sprocket	HDPE	Blue	101,4	-	8	40	100
R40BUN08C40	Wheel				-	-		
D40BUN08C40	Pulley				85,4	-		
P40BUN10C40	Sprocket	HDPE	Blue	127,5	-	10	40	100
R40BUN10C40	Wheel				-	-		
D40BUN10C40	Pulley				111,5	-		
P40BUN12C40	Sprocket	HDPE	Blue	152,8	-	12	40	100
R40BUN12C40	Wheel				-	-		
D40BUN12C40	Pulley				136,8	-		
P40BUN14C40	Sprocket	HDPE	Blue	178,8	-	14	40	100
R40BUN14C40	Wheel				-	-		
D40BUN14C40	Pulley				162,8	-		
P40BUN16C40	Sprocket	HDPE	Blue	204,8	-	16	40	100
R40BUN16C40	Wheel				-	-		
D40BUN16C40	Pulley				188,8	-		
P40BUN18C40	Sprocket	HDPE	Blue	230,7	-	18	40	100
R40BUN18C40	Wheel				-	-		
D40BUN18C40	Pulley				214,7	-		
P40BUN20C40	Sprocket	HDPE	Blue	256,7	-	20	40	100
R40BUN20C40	Wheel				-	-		
D40BUN20C40	Pulley				240,7	-		

Sprockets, wheels and pulleys with 1.5" square bore on request



«THE BELT THAT COMBINES CONVEYANCE AND SYNCHRONOUS DRIVE WITH EXTREME PRECISION»

SERIE 010						
Reference	AG010	AG010+	AG010R	AG010R+	AG010RPI	AG010R+PI
Material	Polyurethane		Polyurethane		Polyurethane	
Colour	Blue		Blue		Blue	
Food	CE / FDA		CE / FDA		CE / FDA	
Top surface	Smooth		Smooth		Spikes	
Bottom side	Smooth		Smooth		Smooth	
Hardness	80 ShA		85 ShA		85 ShA	
Aramid cable reinforcements	NO		YES		YES	
Pitch (mm)	10		10		10	
Teeth WxH (mm)	25x3	25x4.5	25x3	25x4.5	25x3	25x4.5
Thickness (mm)	1.7		1.7		1.7	
Max. width (mm)	350		350		350	
Min. length (mm)	350		940		940	
Weight (kg/m ²)	2		2		2	
Min. pulley diameter (mm)	25		37		37	
Temperature range	-20°C to +40°C		-20°C to +50°C		-20°C to +50°C	
Traction force at 0.5% elongation for a width of 100mm	3 daN		30 daN		30 daN	
Friction coefficient on	HDPE	0.35	0.35		0.35	
	Stainless steel	0.7	0.7		0.7	

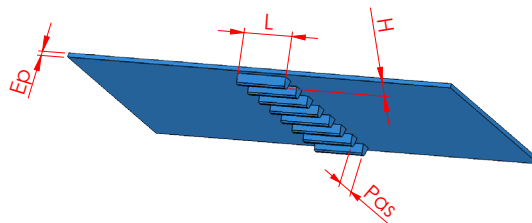



DEL/SYNC®

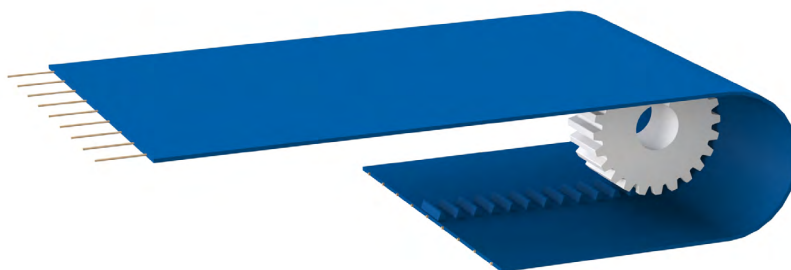

SERIE 100					SERIE 200		
AG110 R	AG110 R+	AG110 RPI	AG110 R+PI	AG110 R+GR	AG208 R	AG212 R	AG212 RP
Polyurethane		Polyurethane		Polyurethane	Polyurethane	Polyurethane	Polyurethane
Blue		Blue		Blue	Blue	Blue	Blue
CE / FDA		CE / FDA		CE / FDA	CE / FDA	CE / FDA	CE / FDA
Smooth		Spikes		Smooth	Smooth	Smooth	Smooth
Smooth		Smooth		Rice grain	Smooth	Smooth	Smooth
95 ShA		95 ShA		95 ShA	95 ShA	95 ShA	95 ShA
YES		YES		YES	YES	YES	YES
10		10		10	8	12.7	12
25x3	25x4.5	25x3	25x4.5	30x4	50x4.5	30x5	50x6
2.3		3.7		2.3	3	3	3
350		350		350	350	390	390
940		940		940	950	950	950
2.9		2.9		2.9	4	4	4
50		50		50	65	65	65
-20°C to +70°C		-20°C to +70°C		-20°C to +70°C	-20°C to +70°C	-20°C to +70°C	-20°C to +70°C
75 daN		75 daN		75 daN	95 daN	95 daN	95 daN
0.25		0.25		0.20	0.25	0.25	0.25
0.6		0.6		0.5	0.6	0.6	0.6

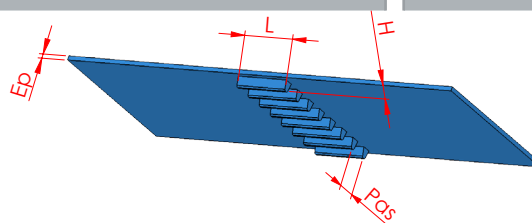

DEL/SYNC®



The positive drive DEL/SYNC® is a **reinforced homogeneous belt combining conveyance and synchronous drive with extreme precision** and hygiene.

It offers **excellent guidance** thanks to internal moulded teeth and **precise positioning** of the transported products.

The DEL/SYNC® is **reinforced with aramid reinforcements** that eliminate elongation.

Both the upper and lower surfaces are easy to clean and ensure **optimal hygiene**.

DEL/SYNC® also works with **small pulley diameters**.

Products in the DEL/SYNC® range offer a belt tailored **to different applications**. Consideration should be given to the need for friction, pulley diameter, loads conveyed, length of conveyor...

We distinguish 3 series of belts in the range:

Series 010: Lightweight, thin belts with a 10mm pitch for use on small pulley diameters.

Series 100: Belts with a 10mm pitch, of greater thickness and strength, used for handling higher loads.

Each belt in these two series is offered in a newer variant with deeper teeth. These belts have the following advantages

- Better guidance on the centre distance, especially in the case of side loading on the belt.
- Better drive on the sprocket when loads are high.

The AG110R+GR belt is available with a rice grain pattern on the bottom, which reduces frictional forces and improves sliding on the conveyor bed, especially in greasy and wet conditions.

Serie 200 : Special belts on request with a pitch of 8 to 12.7mm for long lengths.

Possibility of manufacturing belts with specific characteristics (thickness, hardness, distribution of cords, two coats). Minimum quantity, please consult us.

Reinforced belts are finger jointed.

A molded studded surface is available on request.

Synchronous shaped profiles can be fitted to the belt to ensure accurate indexing of the conveyed products.





DEL/SYNC®

To facilitate the assembly and adjustment of a DEL/SYNC® belt, it is essential to provide a **fixed tension system** with **take up equal to 1.5%** of the length of the conveyor. [-1% ; 0.5% compared to the theoretical distance].

The tension should be checked with the template supplied with the belts.

In the case of belts installed in parallel, **independent tension systems** must be provided.

A mechanical quick release system for the return shaft facilitates the assembly/disassembly of the belt, especially for cleaning operations on the conveyor.

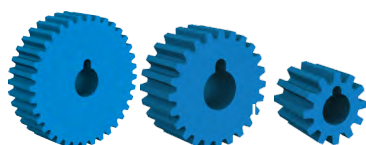
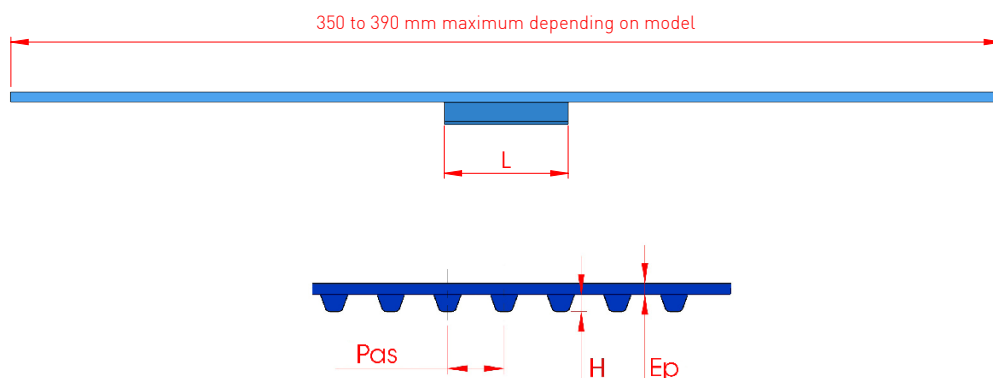
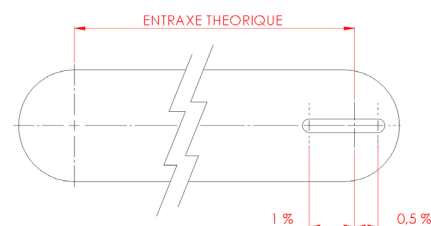

SPROCKETS

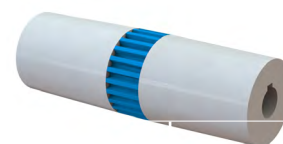

REFERENCE	DEL/SYNC® SERIES	PITCH (mm)	MATERIAL	COLOUR	OUTER Ø (mm)	NUMBER OF TEETH	Ø OF ROUND SHAFT (mm)	WIDTH (mm)
PA10BUN12R16	010	10	HDPE	Blue	37	12	16	33
PA10BUN16R16	010 and 100	10	HDPE	Blue	50	16	16	33
PA10BUN16R25	100 ⁽¹⁾	10	HDPE	Blue	50	16	25	38
PA10BUN24R25	010 and 100	10	HDPE	Blue	74.5	24	25	33
PA10BUN24R25-001	100 ⁽¹⁾	10	HDPE	Blue	74.5	24	25	38
PA10BUN36R25	010 and 100	10	HDPE	Blue	113	36	25	33
PA13WUN24R25	200 ⁽²⁾	12,7	HDPE	White	94.6	24	25	38
PA13WUN36R25	200 ⁽²⁾	12,7	HDPE	White	143.1	36	25	38

(1) Only for AG110R+GR.

(2) Except AG208R and AG212RP (custom made sprockets).

For other sprockets, please consult us.

ACCESSORIES



HIGH FREQUENCY WELDED CLEATED BELTS

- Available on polyurethane (PU) belts only
- No additional materials or adhesives
- Excellent resistance to tearing
- Radiused base of the cleat: facilitates cleaning and prevents microbial development
- Available full width or partial width, centred or offset

VERTICAL CLEATS

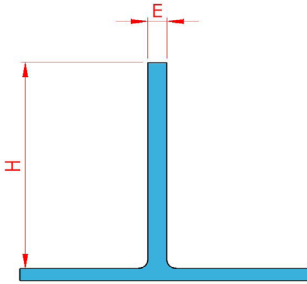

70% ANGLED CLEATS

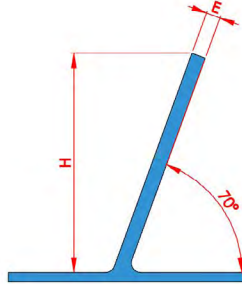

CRANKED CLEATS 90° OR 120°

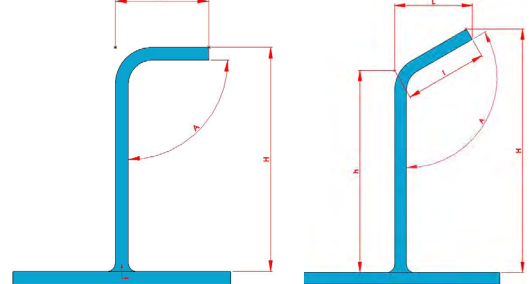

MATERIAL	THICKNESS E (mm)	HEIGHT MAXI CLEATS H (MM)			MAXIMUM WIDTH (mm)	MINIMUM PITCH (mm)
		VERTICAL	ANGLED	CRANKED*		
DEL/DRIVE 50**	2-3-4-5-6-8	140	130	120	1000	50
DEL/DRIVE 50 Antimicrobial	3-5-8 Antimicrobial	140	130	120	1000	50
DEL/DRIVE 25	2-3-4-5	100	100	100	1000	25
POSITIVEBELT P02	3-5-8-10	140	130	120	1000	31,5
POSITIVEBELT P02 Antimicrobial	3-5-8 Antimicrobial	140	130	120	1000	31,5
POSITIVEBELT P01	3-5-8-10	100	NO	NO	400	30,8
S/DRIVE	2-3-4-5-6-8	140	130	120	1000	39,7
DEL/SYNC SERIE 010	3-5	100	NO	NO	350	25
DEL/SYNC SERIE 100	3-5	100	NO	NO	350 ou 390	25
DEL/SYNC SERIE 200	3-5-8	100	NO	NO	350 ou 390	25

* 5 and 8 mm thick only

** 5 or 8 mm thick cleats available embossed on both sides for DDB50B3EM and DDB40B3EMLT

ROUND CLEATS

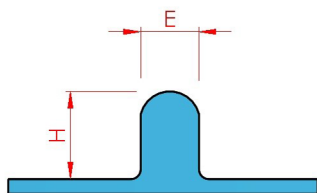

MATERIAL	THICKNESS (mm)	HEIGHT (mm)	MAXIMUM WIDTH (mm)	MINIMUM PITCH (mm)
PU	6	10	1000	31
	8	13		33
	9	14		34
	12	18		37



ACCESSORIES

HOT AIR WELDED CLEATS

- On polyester elastomer DEL/ROC (TPE) belt types
- On PU belts for cranked cleats (angles different from 70°)
- Cleats welded using either one or two electrodes according to cleat thickness
- Excellent resistance to tearing
- Over the entire width of the belt, centered or offset



MATERIAL	THICKNESS (mm)	MINIMUM HEIGHT (mm)	MAXIMUM WIDTH (mm)	MINIMUM PITCH (mm)
TPE	2	15 to 200	1800	≥ 1,25 H
	3			
	4			
	5			

GUSSET (CLEAT SUPPORTS)

Gussets are reinforcements welded behind vertical cleats to provide superior stiffness in the event of higher loads.

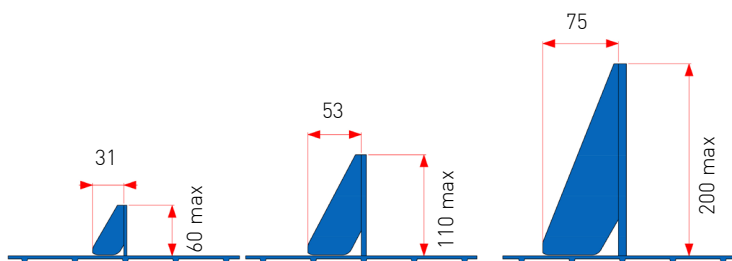

- 3 standard types and 2 thicknesses (5 and 8 mm) are offered depending on the height of the cleats, the load supported and its distribution on the cleat.
- 2 to 5 gussets distributed over the width of the cleat.

OTHER CLEATS

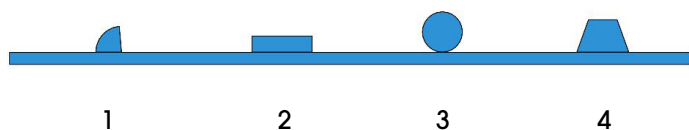

1. Welded cleats
2. Flat profile
3. Round profile
4. Trapezoidal profile

ACCESSORIES



LONGITUDINAL GUIDES

TRAPEZOIDAL PROFILES

Trapezoidal profiles of 6x4mm, 8x5mm, 10x6mm, 13x8mm or 17x11mm can be welded on the upper surface of the belt.



- Arranged over the belt width to channel products.



- On the top side to retain small products.
- Fitted to the edges of a cleated belt to retain the belt in the transition from one angle to another

SIDE WALLS

- For efficient containment of conveyed product (bulk).
- Heights from 20 to 80 mm.
- Belts with mechanical fasteners can also have the walls fastened mechanically.

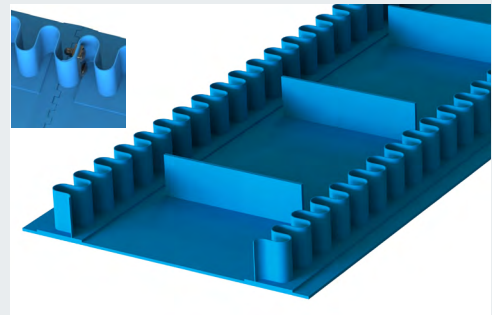

STRAIGHT SIDE WALLS

- For lateral holding of objects on the belt
- Edge height: 20 to 140 mm
- Standard cutting, possibility of adaptation according to the application

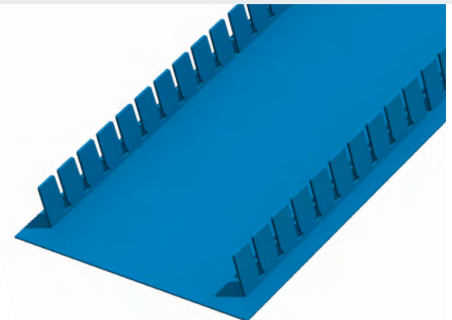

PERFORATIONS

Perforated belts are available:

- for draining,
- for applications where a vacuum is required to hold a product in position.

Diameter, shape and positioning of holes can be discussed with our technical staff. Punching available over the entire belt width up to 1800 mm wide.

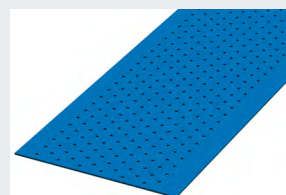
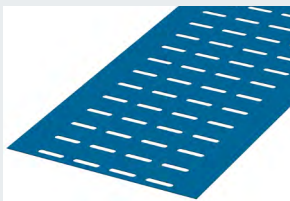

RETAINING CLIP

The retaining clip locks the sprockets, wheels and disks laterally on a square 40x40 mm shaft.





BUTT WELDING

FLAT BELT AND CONVEYOR BELTS UP TO 1100MM IN WIDTH



Welding kit:	Welding blade	Welding table	Box	For belts
KITSOUDURED400 :	MD400	JD400	CAISSE400	width ≤ 400 mm
KITSOUDURED650 :	MD650	JD650	CAISSE650	width ≤ 650 mm
KITSOUDURED1100 :	MD1100	JD1100	CAISSE1100	width ≤ 1100 mm

+ Accessories



1/4 - MOON KNIFE
LUNE



TRIMMING FORK -
F19



CUT RESISTANT GLOVES
GANTS PRO

REFERENCES	WIDTH MAXI (mm)	PRODUCT	VIEW
PLAQMD400-DD25	400	DEL/DRIVE® 25	
PLAQMD650-DD25	650		
PLAQMD1100-DD25	1100		
PLAQMD400-DD50	400	DEL/DRIVE® 50	
PLAQMD650-DD50	650		
PLAQMD1100-DD50	1100		
PLAQMD400-PO-001	400	POSITIVEBELT® PO1	
PLAQMD400-PO	400	POSITIVEBELT® PO2*	
PLAQMD650-PO	650		
PLAQMD1100-PO	1100		
PLAQMD400-SD40	400	S/DRIVE®	
PLAQMD650-SD40	650		
PLAQMD1100-SD40	1100		

*Specific adapters for POSITIVEBELT® PO2H polyester: reference PLAQMD...-PO-002

JOINING METHODS



HOT AIR WELDING

CONVEYOR BELTS WITH A WIDTH OF 1100 TO 1900 MM
WELDING TO THE CORD USING A HOT AIR GUN

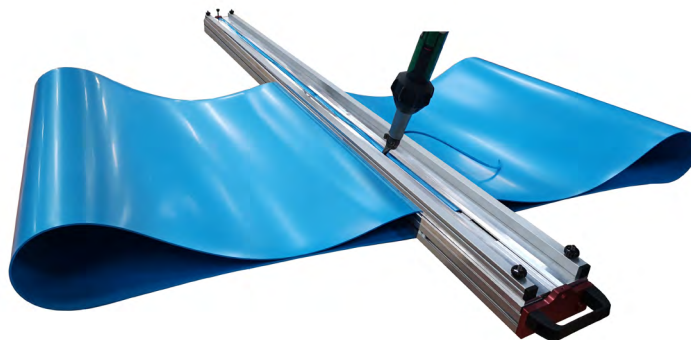

Welding kit:	Welding table	Box	For belts
KITSOUDURET1400 :	T1400	CAISSE1400	width ≤ 1400 mm
KITSOUDURET1900 :	T1900	CAISSE1900	width ≤ 1900 mm

+ Accessories



AFFLEUREUSE-001



FRAISE 60-001



TRIMMING FORK -
F19

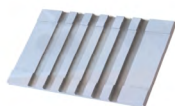

GABARIT-AFFL-001



FRAISE2T-001



CUT RESISTANT
GLOVES -
GANTSPRO

OUT OF KIT

+ TR500



+ BUSE BR5 OU BR7



Hot blowtorch + abusus, not included in the kit.
Contact us



MECHANICALLY FASTEN JOINS



WATCH OUR JOINING VIDEOS ON OUR YOUTUBE CHANNEL



JOINING WITH A HEAT PRESS

DEL/SYNC is joined using a traditional belt press.
The fingers are cut to a specific shape.
The belt press welds at 5 bar.



FASTENERS

The DEL/DRIVE® 50, POSITIVEBELT® and S/DRIVE® conveyor belts can be jointed with mechanical fasteners to facilitate removal and re-fittner.
The clips facilitate removal of the belt by removing the spindle between the 2 ends for quick dismantling and cleaning of the belt and conveyor.

STAINLESS STEEL FASTENERS

- Removable joint comprising 2 half-clips with stainless steel spindle.
- For belts 1.5 mm to 5 mm thick.
- Suitable for all widths.
- Using normal mechanical fastening technics.
- Suitable for all positive drive belts, except DEL/SYNC..

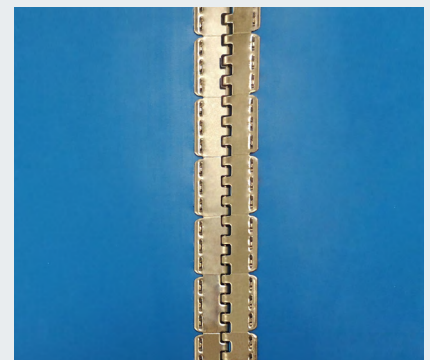

PLASTIC FASTENERS

- Available on certain thicknesses of polyurethane or polyester monolithics. Please enquire.
- Food quality (EC - FDA).
- Allows use on metal detectors.
- Up to 1100 mm in width, above contact us.



SCRAPER



The DEL/CLEAN scraper efficiently cleans the belt, ensuring permanent cleanliness of conveyor belts and avoids:

- clogging up the conveyor
- staining conveyed materials
- loss of materials

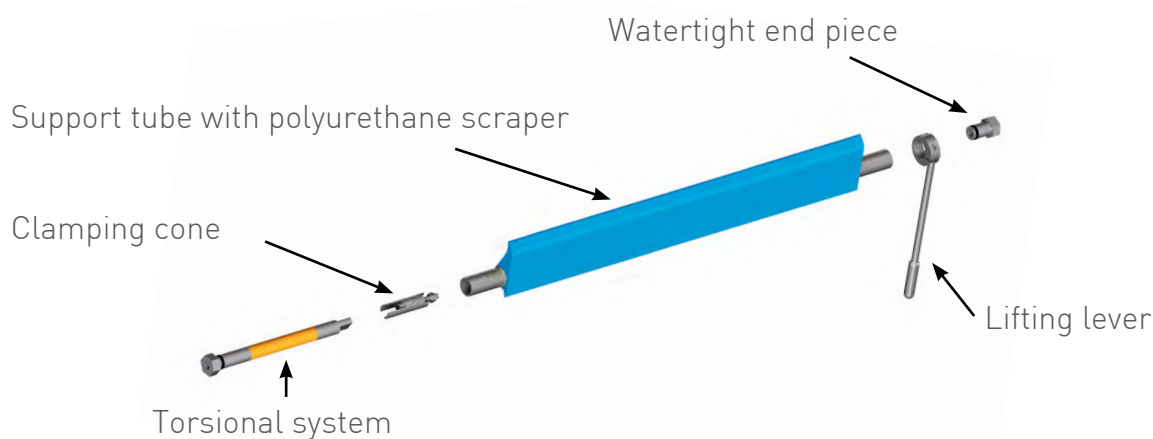

The DEL/CLEAN scraper offers many benefits:

- Small footprint
- No lateral misalignment
- Easy and quick to mount
- Can be adapted to existing or new installations
- Fits all types of conveyor belts
- Easy to clean
- Easier maintenance
- High resistance to hydrolysis: Ether base
- High resistance to abrasion: Ester base

The position of the scraper may vary depending on the need of recover the product.

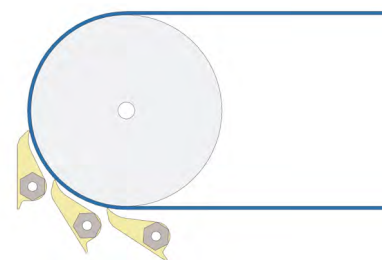

SCRAPER REFERENCE	TUBE	SCRAPER			TORSIONAL SYSTEM REFERENCE	
	Ø (MM)	Height (mm)	Width (mm)	Colour	Single	Reinforced
NT70-22-W	22	70	300 to 1100	White	ST22-S	ST22-R
NT70-22-B				Blue		
NT100-27-W	27	100	400 to 1500	White	ST27-S	ST27-R
NT100-27-B				Blue		



mafdel

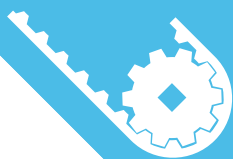

mafdel

Z.I. Lafayette - 131, rue de la Plaine
38790 Saint Georges d'Espérance - FRANCE
Tel. +33 (0)4 78 96 21 90 - mafdel@mafdel.fr

www.mafdel-belts.com



The figures and the data may change. Users of this document should check they are valid. Mafdel accepts no liability for use of incorrect data.
01-2023 Mafdel RCS Vienne B 322 214 412.